

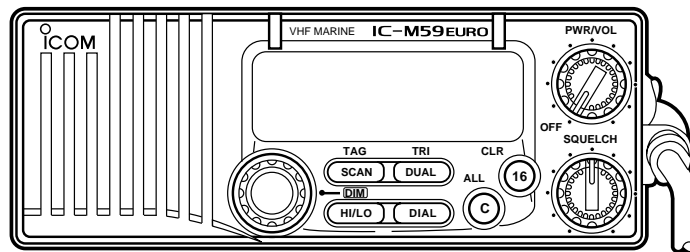

INSTRUCTION MANUAL

VHF MARINE TRANSCEIVER

IC-M59EURO



Icom Inc.

IN CASE OF EMERGENCY

If your vessel requires assistance, contact other vessels and the Coast Guard by sending a distress call on channel 16.

○ **USING CHANNEL 16**

DISTRESS CALL PROCEDURE

1. "MAYDAY MAYDAY MAYDAY"
2. "THIS IS -----" (name of vessel)
3. Your call sign or other indication of the vessel (AND 9-digit DSC ID if you have one).
4. "LOCATED AT -----" (your position)
5. The nature of the distress and assistance required.
6. Any other information which might facilitate the rescue.

Or, transmit your distress call using digital selective calling on channel 70 (the optional UX-120 DSC UNIT with RC-18 DISTRESS SWITCH BOX must be installed).

○ **USING DIGITAL SELECTIVE CALLING (ch 70)** (UX-120 with RC-18 required)

DISTRESS CALL PROCEDURE

1. Lift up the distress switch cover.
2. Push and hold [DISTRESS] for 5 sec. until you hear 5 short beeps change to one long beep.
3. Wait for an acknowledgment from a coast station.
 - When received, channel 16 is automatically selected.
4. Push and hold [PTT], then transmit the appropriate information as at left.

TABLE OF CONTENTS

IN CASE OF EMERGENCY	i		
TABLE OF CONTENTS	ii		
IMPORTANT	iii		
CAUTIONS.....	iii		
1 OPERATING RULES	1		
2 PANEL DESCRIPTION	2–5		
■ Front panel	2		
■ Microphone	3		
■ Function display	4		
■ Distress switch box	5		
3 BASIC OPERATION	6–11		
■ Power ON	6		
■ Channel selection	6		
■ Receiving	8		
■ Transmitting	9		
■ Scan function	10		
■ Call channel programming	11		
■ Display backlighting	11		
■ Voice scrambler function	11		
4 DIGITAL SELECTIVE CALLING	12–17		
■ General	12		
■ Distress call transmission	13		
■ All ships call transmission	14		
■ Receiving DSC calls	15		
5 SET MODE	18–19		
■ Entering SET mode	18		
■ SET mode items	18		
6 CONNECTIONS AND MAINTENANCE	20–24		
■ Unpacking	20		
■ Additional requirements	20		
■ Connections	21		
■ Mounting the transceiver	22		
■ Antenna	23		
■ Fuse replacement	23		
■ Cleaning	23		
■ Optional unit installations	23		
7 VHF MARINE CHANNEL LIST	25		
8 SPECIFICATIONS	26		
9 OPTIONS	27		

IMPORTANT

READ ALL INSTRUCTIONS carefully and completely before using the transceiver.

SAVE THIS INSTRUCTION MANUAL—This instruction manual contains important operating instructions for the IC-M59EURO.

YOU MUST HAVE a DSC vessel ID in order to operate the optional DSC functions of the transceiver. See your Dealer for details.

 The IC-M59EURO complies with the essential requirements of the 89/336/EEC directive for Electromagnetic Compatibility.

CAUTIONS

 **WARNING NEVER** connect the transceiver to an AC outlet. This may pose a fire hazard or result in an electric shock.

 **WARNING HIGH VOLTAGE! NEVER** touch the antenna or an internal antenna connector during transmission. This may result in an electric shock or a burn.

NEVER connect the transceiver to a power source of more than 16 V DC. This connection will ruin the transceiver.

WHEN INSTALLING THE DSC UNIT NEVER transmit a distress call when your vessel does not need immediate help. Distress calls can be used only in times of emergency.

AVOID using or placing the transceiver in direct sunlight or in areas with temperatures below -20°C or above $+60^{\circ}\text{C}$.

DO NOT operate the transceiver without running the vessel's engine. When your vessel's engine is OFF and the transceiver is transmitting, the vessel's battery will soon become exhausted.

KEEP the transceiver out of the reach of children.

KEEP the antenna cable and DC power cable as far away as possible from electrical pumps, generators and other electronic instruments to prevent instrument malfunctions.

KEEP the transceiver and microphone at least 1 meter away from your vessel's magnetic navigation compass.

◇ **Priorities**

- Read all rules and regulations pertaining to priorities and keep an up-to-date copy handy. Safety and distress calls take priority over all others.
- You must monitor channel 16 when you are not operating on another channel.
- False or fraudulent distress calls are prohibited under law.

◇ **Privacy**

- Information overheard but not intended for you cannot lawfully be used in any way.
- Indecent or profane language is prohibited.

◇ **Radio licenses**

SHIP STATION LICENSE

When your craft is equipped with a VHF FM transceiver, you must have a current radio station license before using the transceiver. It is unlawful to operate a ship station which is not licensed.

Inquire through your dealer or the appropriate government agency for a Ship-Radiotelephone license. This license includes the call sign which is your craft's identification for radio purposes.

OPERATOR'S LICENSE

A restricted Radiotelephone Operator Permit is the license most often held by small vessel radio operators when a radio is not required for safety purposes.

The Restricted Radiotelephone Operator Permit must be posted near the transceiver or be kept with the operator. Only a licensed radio operator may operate a transceiver.

However, non-licensed individuals may talk over a transceiver if a licensed operator starts, supervises, ends the call and makes the necessary log entries.

A current copy of the applicable government rules and regulations is only required to be on hand for vessels in which a radio telephone is compulsory. However, even if you are not required to have these on hand it is your responsibility to be thoroughly acquainted with all pertinent rules and regulations.

■ Front panel

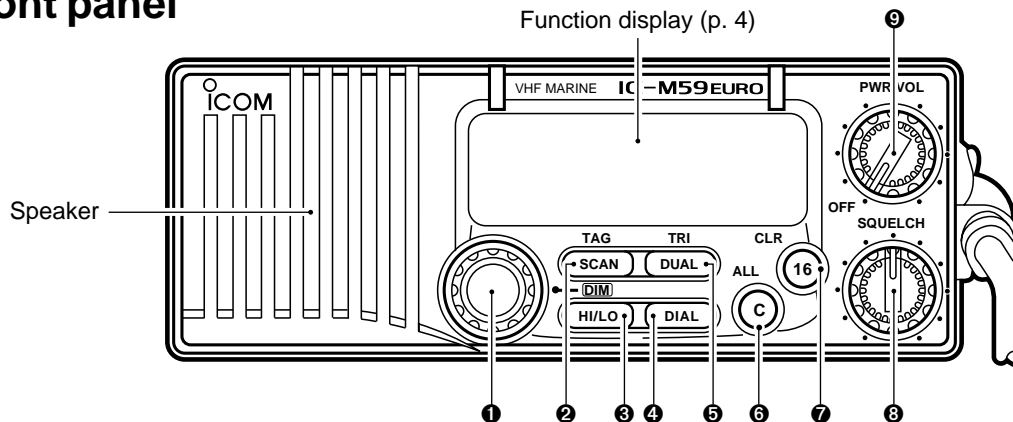

❶ CHANNEL SELECTOR

Selects an operating channel in the selected channel group.

❷ SCAN SWITCH [SCAN•TAG]

- Starts and stops priority or normal scan when tag channels are programmed. (p. 10)
- Push and hold for 1 sec. to toggle the tag setting for the displayed channel. (p. 10)
- Push and hold for 3 sec. together with the [H/L] key to clear all tag channels. (p. 10)

❸ HIGH/LOW POWER SWITCH [HI/LO•DIM]

- Toggles between high and low output powers. (p. 9)
- While pushing, rotate the channel selector to adjust the display and control/switch backlighting intensity. (p. 11)

❹ DIAL SWITCH [DIAL]

- Selects the International channel group. (p. 7)
- For U.K./Italy versions, the U.S.A. channel group is also available. To toggle between international and U.S.A. channels, push and hold this switch for 1 sec. (p. 7)

⑤ **DUAL/TRI-WATCH SWITCH [DUAL•TRI]**

- Activates dualwatch for checking channel 16. (p. 8)
- Push and hold for 1 sec. to activate tri-watch for checking channel 16 and the call channel. (p. 8)

⑥ **CALL CHANNEL SWITCH [C•ALL]**

- Selects the call channel—the call channel is programmable. (p. 11)
- Push and hold for 1 sec. to enter the standby condition of an all ships call. (When an optional UX-120 is installed). (pgs. 14, 15)
 - ➡ Three categories (distress, safety and urgency) are selectable.

⑦ **CHANNEL 16 SWITCH [16•CLR]**

- Selects channel 16. (p. 6)
- Cancels the distress call. (when an optional UX-120 is installed). (p. 13)

⑧ **SQUELCH CONTROL [SQUELCH]**

Rotate clockwise to eliminate audio noise. (p. 8)

⑨ **POWER/VOLUME CONTROL [PWR/VOL]**

Turns power ON and OFF and adjusts the audio output level. (p. 6)

■ **Microphone**

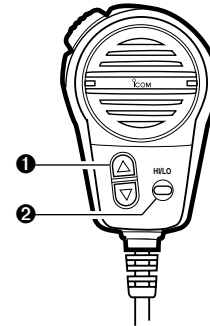

① **CHANNEL UP/DOWN SWITCHES [▼]/[▲]**

- Select an operating channel.

② **HIGH/LOW POWER SWITCH [HI/LO]**

The same function as the transceiver's front panel.

- Toggles between high and low output powers. (p. 9)
- While pushing, rotate the channel selector to adjust the display and control/switch backlighting intensity. (p. 11)

2 PANEL DESCRIPTION

■ Function display

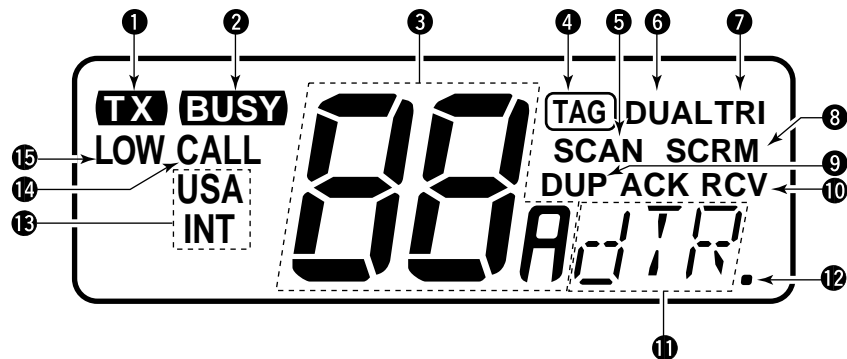

1 TRANSMIT INDICATOR

Appears while transmitting. (p. 9)

2 BUSY INDICATOR

Appears when receiving a signal or when [SQUELCH] is rotated too far counterclockwise. (p. 8)

3 CHANNEL INDICATOR

Shows the operating channel. (pgs. 6, 7)

4 TAG CHANNEL INDICATOR

Appears when the selected channel is set as a tag channel. (p. 10)

5 SCAN INDICATOR

Appears and flashes during scan operation. (p. 10)

6 DUALWATCH INDICATOR

Appears and flashes during dualwatch operation. (p. 8)

7 TRI-WATCH INDICATOR

Appears and flashes during tri-watch operation. (p. 8)

8 VOICE SCRAMBLER INDICATOR

Appears while the optional voice scrambler is activated. This function is permitted in some countries only. (p. 11)

9 DUPLEX INDICATOR

Appears when the selected channel is a duplex channel (p. 7).

10 ACKNOWLEDGEMENT/RECEIVE INDICATORS

Appear during optional DSC operation. (pgs. 13–17)

- “RCV” appears when a DSC call is received.
- “ACK RCV” appears when an acknowledgement is received.
- “ACK” and “**T X**” appear when transmitting an acknowledgement.

11 DSC INDICATORS (pgs. 13–17)

Appear during optional DSC operation and show a format specifier, category, etc.

12 NMEA INDICATOR

Appears when NMEA devices (such as a GPS receiver) are connected. (p. 12)

13 MODE INDICATORS (p. 7)

- “INT” shows International channels are selected.
- For U.K./Italy versions; U.S.A. channels are available. “USA” appears when selected.

14 CALL CHANNEL INDICATOR

Appears when the call channel is selected. (p. 6)

15 LOW POWER INDICATOR

Shows that low output power is selected. (p. 9)

Distress switch box (UX-120 required)

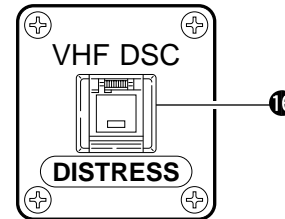

16 DSC DISTRESS SWITCH [DISTRESS]

Lift the cover, then push and hold for 5 sec. to transmit a DSC distress call. (p. 13)

■ Power ON

- ① Rotate [PWR/VOL] clockwise to turn power ON.



All display indications appear briefly*.

* "dSC" appears only when an optional UX-120 is installed.

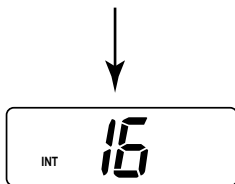

- ② Operate the transceiver as indicated in the following sections.

◇ Low voltage indicator

When "b" appears and flashes as shown at right, there is a DC power source problem. In this case, check your vessel's battery and DC power cable.



■ Channel selection

◇ Channel 16

Channel 16 is the distress channel. It is used for establishing initial contact with another station and for emergency communications. Channel 16 is monitored during dualwatch/tri-watch. While standing by you are required to monitor channel 16.

Push



or hang the microphone on the microphone hanger.

◇ Call channel

The call channel is used to store your most often-used channel for quick recall. In addition, the call channel is monitored during tri-watch. The default setting for the call channel is differ depending on version.

Push



"CALL" indicates that the call channel is selected.

◇ **International channels**

There are 55 international channels for the IC-M59EURO.

- ① Push [DIAL] to select an international channel.
- ② Rotate the channel selector to select a channel.
 - “DUP” appears for duplex channels.

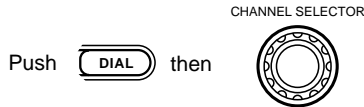

or rotate the channel selector directly without using the [DIAL] switch.



Simplex channel
Used for ship-to-ship communication



Duplex channel
Used for ship-to-coast communication

◇ **U.S.A. channels** (U.K. and Italy versions only)

For the U.K. and Italy versions, there are 61 U.S.A. channels in addition to 55 international channels. These channel groups may be specified for the operating area.

- ① Push [DIAL] to select a regular channel.
- ② Push and hold [DIAL] for 1 sec. to toggle the international and U.S.A. channels.
- ③ Rotate the channel selector to select a channel.
 - Channels are memorized separately for each channel group.

/// The previously selected channel is recalled by the [DIAL] switch directly from channel 16 or the call channel. However, once the channel selector is rotated from channel 16 or the call channel, the previously selected channel cannot be recalled in this manner.

3 BASIC OPERATION

■ Receiving

- ① Rotate [PWR/VOL] to turn power ON.
- ② Rotate [SQUELCH] fully counterclockwise.
- ③ Adjust [PWR/VOL] to a suitable listening level.
- ④ Rotate [SQUELCH] clockwise until the audio noise disappears.
- ⑤ Select the desired channel. See pgs. 6–7 for details.

• When a signal is received:

- ▶ The squelch opens;
- ▶ Audio is emitted from the speaker;
- ▶ “BUSY” appears in the function display.



◇ Dual/tri-watch functions

These functions allow you to conveniently check the distress channel (ch 16) or, both the distress and programmable call channel while receiving another channel. When receiving a signal on one of these channels, the transceiver stops on the channel until the signal disappears.

• Dualwatch operation

➔ Push [DUAL•TRI] momentarily for dualwatch.

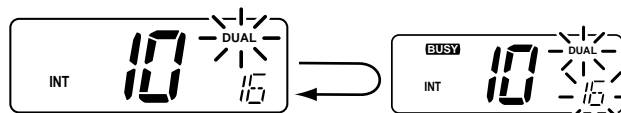

Checking channel 16 every 2 sec.

When receiving a signal on channel 16. Channel 16 is monitored until the signal disappears.

• Tri-watch operation

➔ Push and hold [DUAL•TRI] for tri-watch.

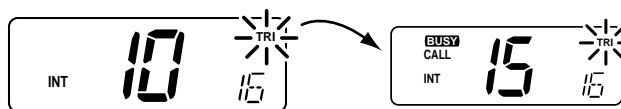

Checking channel 16 and the call channel every 2 sec.

When receiving a signal on the call channel, the call channel is monitored while checking ch 16 in 2 sec. intervals.



When receiving a signal on channel 16, channel 16 has priority.

■ Transmitting

Before transmitting, read the call procedures at right.

- ① Select an operating channel. See pgs. 6, 7 for details.
- ② Push [HI/LO] to select transmit output power.
 - “LOW” appears when low output power is selected.
 - High power cannot be selected on some channels. Refer to the channel list on p. 25.
- ③ Push and hold the PTT switch to transmit.
 - “TX” appears.
- ④ Speak into the microphone at your normal voice level.
 - Do not hold the microphone too closely to your mouth or speak too loudly. This may distort the transmit signal.
- ⑤ Release the PTT switch to receive.

IMPORTANT: In order to maximize the readability of your transmitted signal, pause for a moment after pushing [PTT], hold the microphone 15–20 cm from your mouth, then speak into the microphone at an even, normal voice level.

MOMENTARY HIGH POWER (U.K./Italy versions only)

On U.S.A. channels 13, 15 and 67, transmission using high power is momentarily possible. To use high power, push and hold [HI/LO] while transmitting.

CALL PROCEDURES

You must identify yourself when you transmit and you must respect time limits.

- 1) Give your call sign each time you call another vessel or a coast station. If you have no call sign, identify the station by giving the vessel name and the name of the license.
- 2) Give your call sign at the end of each transmission that lasts more than 3 minutes.
- 3) You must pause and give your call sign at least once every 15 minutes during long ship-to-shore calls.
- 4) Keep your calls short (less than 3 minutes). Wait 2 minutes before repeating a call.
- 5) Unnecessary transmissions are not allowed.

3 BASIC OPERATION

■ Scan function

The transceiver has a high speed scan function (8 channels/sec.) for standing by on utility signals.

Two scan types are available: *priority scan* (checks channel 16 while scanning all tag channels) and *normal scan* (scans all tag channels in sequence). These scans can be selected in set mode (p. 19).

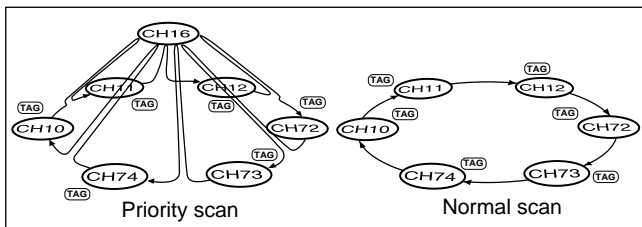

✓ Scan resume timer:

When a signal is detected, scan pauses until the signal disappears or resumes after pausing 5 sec., according to the set mode setting. (p. 19)

✓ Confirming tag channels:

While operating scan, rotate the channel selector.

- Only tag channels are selected.
- Stop rotating the channel selector to resume scan.

◇ Setting tag channels

You can specify channels as tag channels for efficient scanning.

- ➔ Select the desired channel, then push and hold [SCAN•TAG] for 1 sec. to toggle the tag setting.

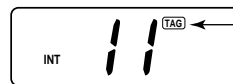

Appears when the channel is specified as a tag channel.

✓ Clearing all tag channels:

While pushing [HI/LO], push and hold [SCAN•TAG] for 3 sec. until the long beep becomes 2 short beeps.

NOTE: For U.K. and Italy versions, tag channels can be set separately for each channel group (INT, USA). Select the desired group in advance.

◇ Scan operation

- ① Be sure the squelch is set to the threshold point.
- ② Push [SCAN] to start scanning.
 - “SCAN” appears and flashes in the function display.
 - “16” appears during priority scan.
- ③ To stop the scan, push [SCAN] again.
 - “SCAN” disappears.

■ Call channel programming

The call channel key, [C], is used to select the call channel which you can program your most often-used channels.

- ① Push [C] to select the call channel.
 - “CALL” and the call channel number appear.
- ② While pushing [HI/LO] push [C] to enter call channel write mode.
 - Call channel number flashes.
- ③ Rotate the channel selector to select the desired channel.
- ④ Push [C] again to program the displayed channel as the call channel.
 - The call channel number stop flashing.

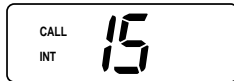
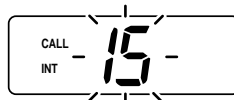
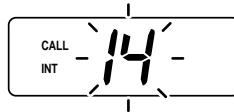

NOTE: For U.K./Italy versions, a call channel is available separately for each channel group (INT, USA). Select the desired channel group in advance.

■ Display backlighting

The function display and switches can be backlit for better visibility under low light conditions.

While pushing [HI/LO•DIM], rotate the channel selector to adjust the backlighting.

➔ Backlighting can be set to 1 of 3 intensities or turned OFF.

■ Voice scrambler function

Some countries prohibit the use of voice scrambled communications. An optional UT-79 VOICE SCRAMBLER UNIT is necessary to use this function.

➔ While pushing [HI/LO], push [DIAL] to toggle the function ON and OFF.

• “SCRM” appears when the function is ON.

• This function cannot be used on channel 16.

• Set the scramble code in SET mode in advance (p. 19).



■ General

When an optional UX-120 DSC UNIT with RC-18 DISTRESS SWITCH BOX is installed, digital selective calling (DSC class-F) is available with via the IC-M59EURO.

DSC is a method of radio communications involving digital signals rather than the more conventional method of voice communications. The advantage of using digital communications over voice communications is that information (espe-

cially useful for distress calls and other urgent matters) can be pre-programmed into a radio and transmitted accurately.

In addition, when a GPS receiver (NMEA0183 ver. 1.5, 2.0 or 2.1) is connected, your vessel's position and the current UTC time are transmitted together with the vessel's identity when making a distress call.

See pgs. 23, 24 for unit installation.

DSC TYPE	DESCRIPTION	REF.
Distress call	This sends distress information which includes your vessel's ID (and position data/UTC time when a GPS receiver is connected). Send under <i>emergency conditions only</i> . DSC acknowledgement will be received from a coast station after making a distress call.	pgs. 13, 16
Distress relay call	This is used to alert Coast stations (or other ships) when a vessel in distress is unable to do so. The IC-M59EURO can <i>only receive</i> this type of signal; not transmit.	p. 16
All ships call	This signal includes a category and channel data which allows a receiving transceiver to automatically select channel 16 for voice communication.	pgs. 14, 16
Individual call	This is used for calling to a specific vessel. The IC-M59EURO has no individual call transmission capability, but has receive capability. Two kinds of acknowledgements (able to comply/unable to comply) are available after receiving an individual call.	pgs. 15, 17
Geographical area call	This is used for announcement to all ships in the specified area—when a GPS receiver is connected calls directed to areas other than yours are rejected. <i>Receive only</i> for the IC-M59EURO.	p. 17

■ Distress call transmission

CAUTION: Distress calls may be transmitted under conditions of emergency only i.e. your vessel is in danger of sinking and/or a person's life is in danger.

- ① Lift the cover on the DSC box and push [DISTRESS] for 5 sec.



- Channel 70 is automatically selected and a distress call is transmitted.



- To cancel the distress call before the 5 sec. have elapsed, release [DISTRESS] or push [16•CLR].



- ② The transceiver remains on channel 70 until an acknowledgement is received.

- The [DISTRESS] switch and "dTR" flashes until an acknowledgement is received.
- When no acknowledgement is received, the distress call is repeated at random intervals every 3.5 to 4.5 min. until an acknowledgement is received.
- To cancel this, push [16•CLR]—channel 16 is selected.
- Calls to you other than distress acknowledgement cannot be received.

- ③ When a distress acknowledgement is received, emergency alarm sounds and channel 16 is automatically selected.
- Push [16•CLR] to stop the alarm.

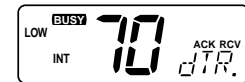

- ④ Transmit your distress call particulars by voice using the following procedure:

1. "MAYDAY."
2. "THIS IS (name of your vessel)."
3. The 9-digit identity AND the call sign (or other vessel identification).
4. Your vessel's position if DSC does not include it.
5. The nature of the distress and assistance required.
6. Any other information which might facilitate the rescue.

NOTE: When a GPS receiver (NMEA 0183) is connected, your vessel's position is automatically transmitted with the distress call.

NOTE: Acknowledgement of a DSC distress alert is normally made by coast stations only.

4 DIGITAL SELECTIVE CALLING

■ All ships call transmission

Large ships use channel 70 as their “listening channel.” When you want to announce a message to these ships, use the “all ships call” function.

- ① Rotate [SQUELCH] clockwise until the audio noise disappears.
- ② Push and hold [C•ALL] then rotate the channel selector to select a category:
 - URG (urgency) ... Used for urgent announcements (Use for general ship-to-ship calls)
 - SAF (safety) Used for sending safety information.
 - dTR (distress) Used for specifying a Narrow Band Direct Printer (NBDP) after DSC connection.



- ③ Keep pushing [C•ALL] for 5 sec. until you hear 4 short beeps change to one long beep.
 - The all ships call is automatically transmitted.
 - The display changes as at right.

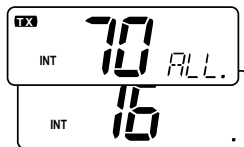

- ④ Push and hold [PTT] to send an announcement via the microphone to all ships.

NOTE: *Channel busy*
When channel 70 is busy, the all ships call (with urgency category) is not transmitted. The transceiver waits until the channel is clear, then transmits the call automatically. Push [16•CLR] to cancel the all ships call while waiting.









This display appears while the call is in standby.

■ Receiving DSC calls

Several types of DSC transmissions can be received. The required action depends on the particular DSC type as outlined in the following examples. However, in all examples, you must be monitoring channel 70 in order to receive such signals.

NOTE: When channel 70 is set as a tag channel and scan is functioning, DSC calls will not be received. DSC calls can only be received when channel 70 is selected.

<p>When a distress call is received</p> 	<p>When a distress relay call is received</p> 
<p>When an all ships call is received</p> 	<p>When a geographical area call is received</p> 
<p>When an individual call is received</p>  <p>Able to comply is pre-selected, and channel 12 is specified.</p>	 <p>Unable to comply is pre-selected.</p>

◇ Receiving a distress call

While monitoring channel 70 and a distress call is received:

- ➔ Emergency alarm sounds.
- ➔ “RCV” and “dTR” appear in the display; then, channel 16 is automatically selected.
- ➔ Push [16] to stop the alarm.
- ➔ Continue monitoring channel 16 as a coast station may require assistance in any rescue attempt.

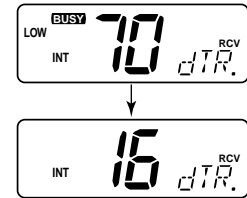

◇ Receiving a distress relay call

A distress relay call may be transmitted from a large ship to a coast station. While monitoring channel 70 and a distress relay call is received:

- ➔ Emergency alarm sounds.
- ➔ “RCV” and “RLY” appear in the display; then, channel 16 is automatically selected.
- ➔ Push [16] to stop the alarm.
- ➔ Monitor channel 16 until the emergency communication has been completed.

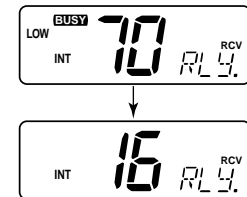

4 DIGITAL SELECTIVE CALLING

◇ Receiving an all ships call

While monitoring channel 70 and an all ships call is received:

- ➔ Beeps or emergency alarm sound.
 - Beeps sound when received call contains the urgency routine (general all ships call).
 - Emergency alarm sounds when received call contains the safety or distress category.
- ➔ “RCV” and “ALL” appear in the display; then, the channel specified by calling station is automatically selected for voice communications.
- ➔ Monitor the selected channel for an announcement from the calling station.

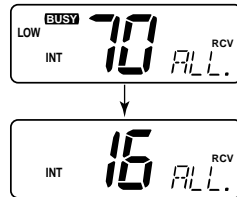

◇ Receiving an individual call

When receiving an individual call, an acknowledgement is transmitted automatically. The contents of the acknowledgement must be specified in advance. Refer to p. 19 for setting.

Two messages can be selected for acknowledgement:

- “Able to comply”:
You can communicate with the calling vessel via the mic after a DSC connection.
- “Unable to comply”:
You cannot communicate with the calling vessel after a DSC connection (e.g. operator leaves transceiver).

While selecting “Able to comply” and an individual call is received:

- Emergency alarm or beeps sound depending on the received category.
- The transceiver automatically transmits an acknowledgment (with able to comply).
- The channel specified by the calling station is automatically selected.
- Communicate with the calling station when he or she requires such.

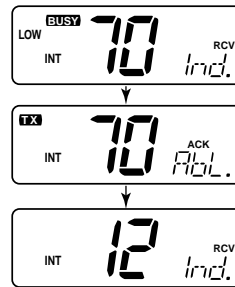

While selecting “Unable to comply” and an individual call is received:

- Emergency alarm or beeps sound depending on the received category.
- The transceiver automatically transmits an acknowledgment (with unable to comply).
- The channel remains on channel 70.

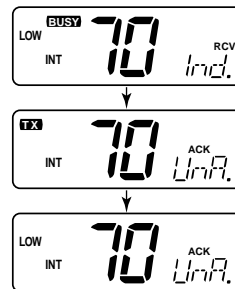

◇ Receiving a geographical area call

While monitoring channel 70 and a geographical area call (for the area you are in) is received:

- Emergency alarm or beeps sound depending on the received category.
- “RCV” and “GEO” appear in the display; then, the channel specified by the calling station is automatically selected for voice communications.
- Monitor the selected channel for an announcement from the calling ship.

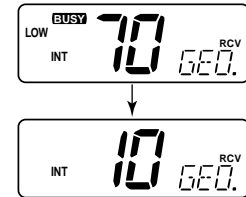

NOTE: When no GPS receiver is connected, or if there is a problem with the connected receiver or if the NMEA data is wrong, all geographical area calls are received, regardless of your position.

■ Entering SET mode

SET mode is used to customize operation of the transceiver to suit your operating needs.

◇ To enter SET mode:

- ① While pushing [16], turn power ON.
 - Keep pushing [16] until the initial SET mode display appears.
 - SET mode is selected.
- ② To exit SET mode, turn power OFF then ON again.

◇ To select an item:

There are up to 5 items in SET mode (depending on options installed) that may be adjusted to suit your operating needs.

- ① Select SET mode as above.
- ② Push [16] to select the desired item; then rotate the channel selector to select the desired condition.
 - See the following pages for details on each SET mode item.

■ SET mode items

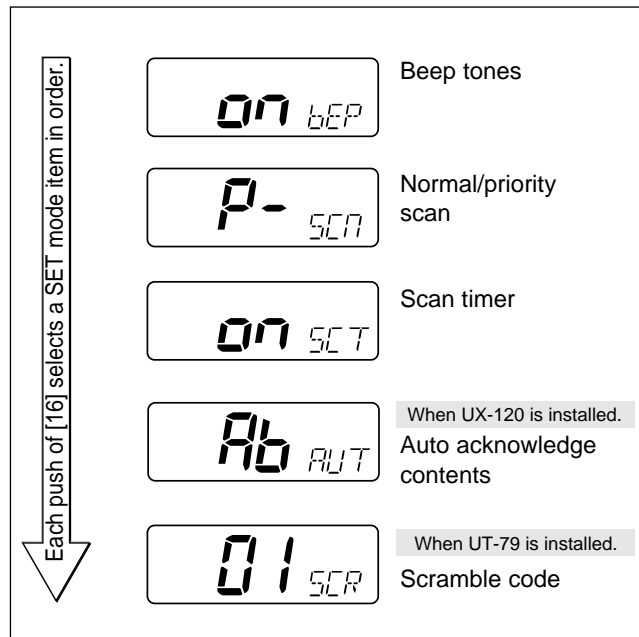

/// The diagram above shows the default settings for each SET mode item and the order of selection.

◇ **BEEP TONES**

This item sets the transceiver's confirmation beep tones (when pushing a switch/rotating 'channel selector') ON or OFF.

Beep tones ON (default)



Beep tones OFF



/// **NOTE:** Emergency alarm and beeps for DSC operation cannot be turned OFF.

◇ **NORMAL/PRIORITY SCAN**

This item sets the scan function to normal or priority operation. (See p. 10)

Priority scan (default)

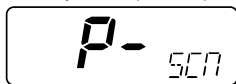

Normal scan



◇ **SCAN TIMER**

This item sets the scan timer ON or OFF.

Scan timer ON (default)



Scan timer OFF

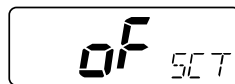

- Scan pauses on a signal and resumes 5 sec. later.

- Scan pauses on a signal until the signal disappears, and resumes 2 sec. after that.

◇ **AUTO ACKNOWLEDGE CONTENTS**

(appears when the UX-120 is installed)

This item sets "unable to comply" or "able to comply" as the automatic acknowledgement when receiving an individual call. (p. 16)

Able to comply (Default)



Unable to comply



◇ **SCRAMBLE CODE**

(available only where permitted by law; appears when the UT-79 is installed.)

This item sets a scramble code for communication using the optional voice scrambler unit. (p. 11)

Scramble code "0"



Scramble code "127"

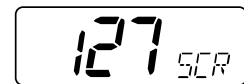

■ Unpacking

- ① Mounting bracket 1
- ② DC power cable (OPC-355) 1
- ③ Microphone hanger (OPC-562) 1
- ④ Mounting bracket knobs 4
- ⑤ Mounting screws (5×20) 4
- ⑥ Mic hanger screws (3.5 × 30) 2
- ⑦ Flat washers (M4) 2
- ⑧ Spare rubber cap* (except Italy version) 1

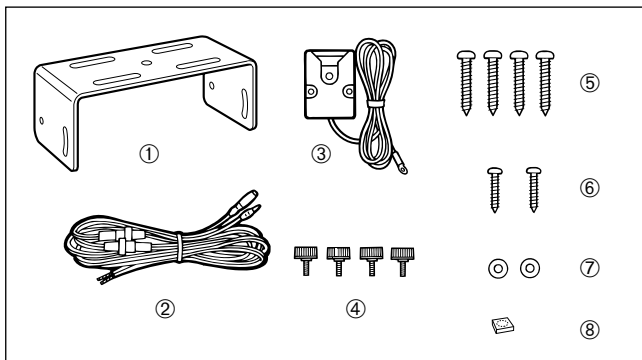

* Attach the rubber cap after attaching the microphone hanger.

■ Additional requirements

◇ For general operation

- Marine VHF antenna
- Coaxial cable

◇ For DSC operation

- UX-120 DSC UNIT with RC-18 DISTRESS SWITCH BOX

◇ For enhanced DSC operation

- GPS receiver with NMEA0183 output for sending positioning and time data with a distress call.
- The optional UX-120 with RC-18 is required for connection.

◇ For voice scrambler operation

- UT-79 VOICE SCRAMBLER UNIT
- Consult with your dealer if you need this function—This function is permitted in some countries only.

Connections

/// The rear panel for the Italy version differs slightly from that shown here, however connections are basically the same.

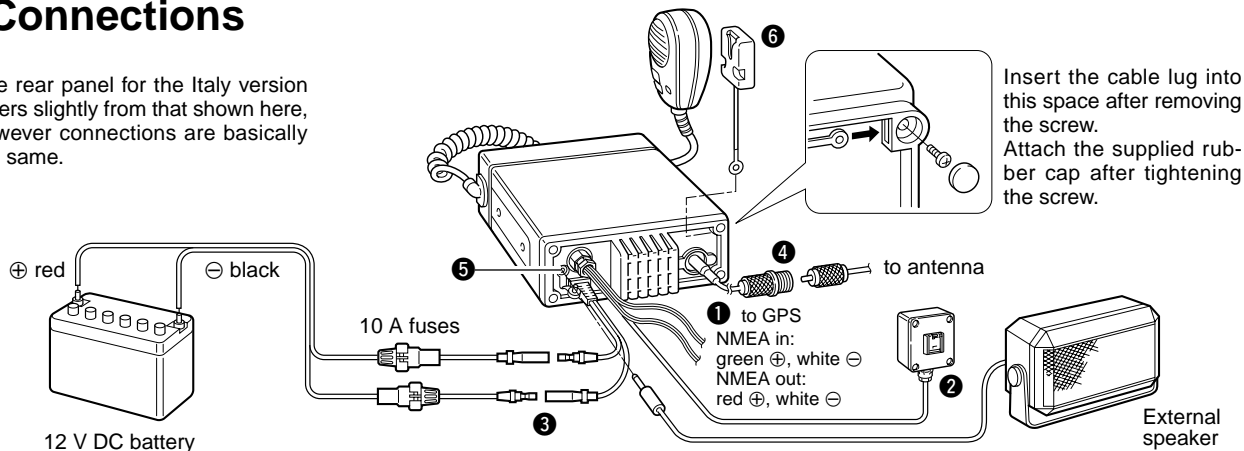

- 1 NMEA CABLE** (from the UX-120)*
Allows you to connect an NMEA device, such as a GPS receiver, to the IC-M59EURO.
Acceptable command: GGA
Acceptable format: NMEA0183 ver. 1.5, 2.0 or 2.1
- 2 RC-18 DISTRESS SWITCH BOX** (optional)*
Allows you to make DSC distress calls when the optional UX-120 DSC UNIT is installed.

/// When the OPC-457 is attached or is set as an option, see below.

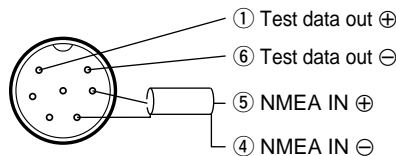

- 3 DC POWER CONNECTOR**
Connects the supplied DC power cable from this connector to an external 12 V DC power source.

- 4 ANTENNA CONNECTOR**
Connects a marine VHF antenna with a PL-259 connector to the transceiver. **CAUTION:** Transmitting without an antenna will damage the transceiver.
- 5 EXTERNAL SPEAKER JACK**
- 6 MICROPHONE HANGER**
Connects to the transceiver's casing screw. Resting the microphone on the hanger automatically selects channel 16.

6 CONNECTIONS AND MAINTENANCE

■ Mounting the transceiver

The universal mounting bracket supplied with your transceiver allows overhead or dashboard mounting. Please read the following instructions carefully.

- Mount the transceiver securely with the 4 supplied screws (M5×20) to a surface which is more than 10 mm thick and can support more than 5 kg.
- Mount the transceiver so that the face of the transceiver is at 90 ° to your line of sight when operating it.

CAUTION: KEEP the transceiver and microphone at least 1 meter away from your vessel's magnetic navigation compass.

NOTE: Check the installation angle; the function display may not be easy-to-read at some angles.

NOTE FOR SUPPLIED STICKER

When installing an optional UX-120 DSC UNIT with RC-18 DSC UNIT:

Attach the WARNING sticker supplied with the UX-120 near the transceiver's front panel so that it is clearly visible during operation.

DASHBOARD MOUNTING (with optional MB-28)

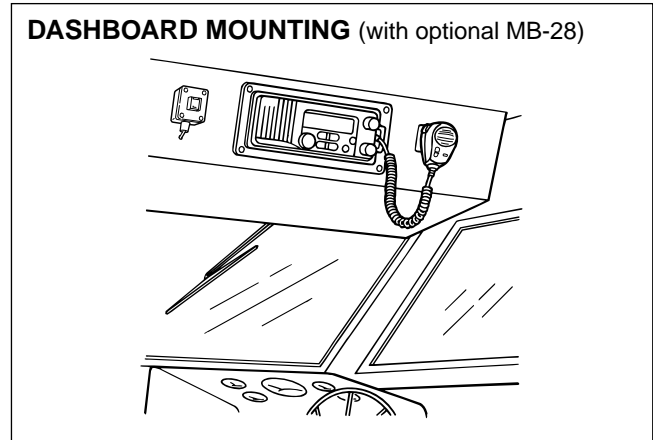

OVERHEAD MOUNTING

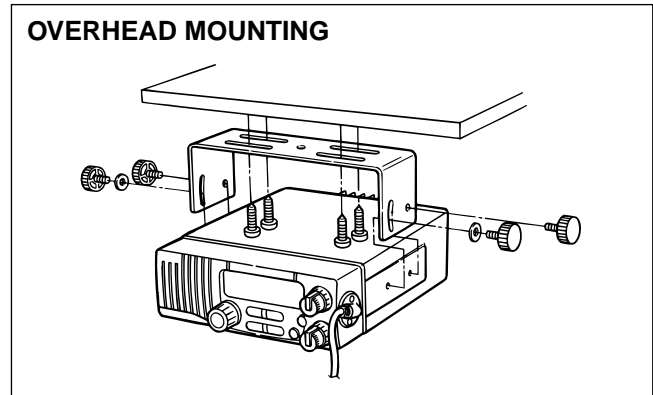

■ Antenna

A key element in the performance of any communication system is an antenna. Ask your Dealer about antennas and the best places to mount them.

■ Fuse replacement

Two fuses are installed in the supplied DC power cable. If a fuse blows or the transceiver stops functioning, track down the source of the problem, if possible, and replace the damaged fuse with a new, rated one.

→ Fuse rating: 10 A

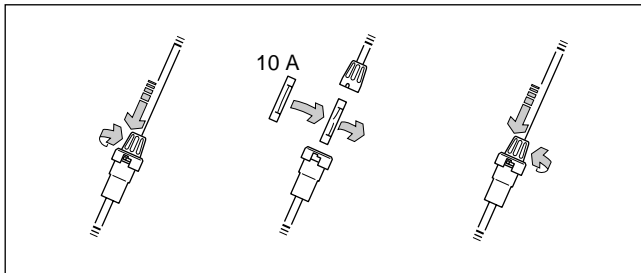

■ Cleaning

If the transceiver becomes dusty or dirty, wipe it clean with a dry, soft cloth.



AVOID the use of solvents such as benzene or alcohol, as they may damage transceiver surfaces.

■ Optional unit installations

In order to add the DSC or voice scrambler functions to the IC-M59EURO, the following optional units must be installed.

UX-120: DSC functions and GPS connection

UT-79: Voice scrambler function

- ① Turn the transceiver power OFF and disconnect the DC power cable.
- ② Unscrew 4 screws from the rear panel, then remove the heatsink cover and transceiver cover. (fig. 1; next page)
- ③ Install the desired unit. (fig. 2 and 3; next page)
- ④ Replace the transceiver cover and tighten the screws.
 - 4 to 6 kg of torque MUST be applied to ensure water resistance.

6 CONNECTIONS AND MAINTENANCE

Opening the transceiver case
(Fig. 1)

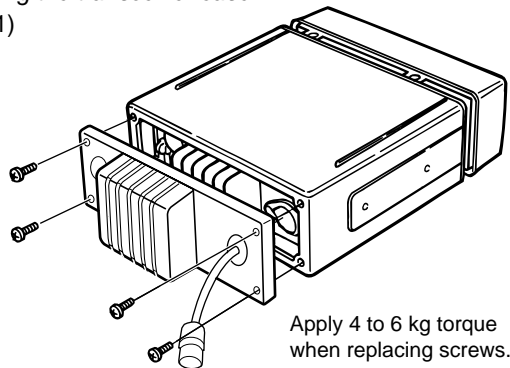

UX-120 installation (Fig. 3)

- ① Secure the UX-120 in place with 2 supplied screws.

Be careful not to shift the connector.

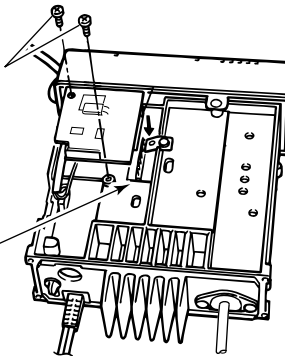

UT-79 installation (Fig. 2)

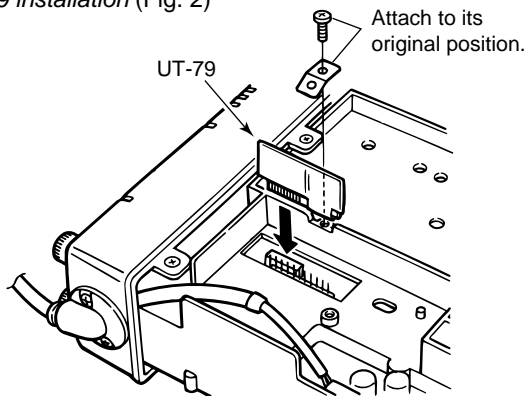

- ④ Connect onto the UX-120.
- ② Remove the plastic cover.
- ③ Pass the cable through, then tighten the cable nut.

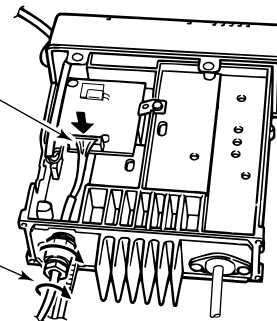

VHF MARINE CHANNEL LIST

7

•International channels

CH	Frequency (MHz)		CH	Frequency (MHz)		CH	Frequency (MHz)		CH	Frequency (MHz)		CH	Frequency (MHz)		CH	Frequency (MHz)	
	Transmit	Receive		Transmit	Receive		Transmit	Receive		Transmit	Receive		Transmit	Receive		Transmit	Receive
01	156.050	160.650	11	156.550	156.550	21	157.050	161.650	62	156.125	160.725	72	156.625	156.625	84	157.225	161.825
02	156.100	160.700	12	156.600	156.600	22	157.100	161.700	63	156.175	160.775	73	156.675	156.675	85	157.275	161.875
03	156.150	160.750	13	156.650	156.650	23	157.150	161.750	64	156.225	160.825	74	156.725	156.725	86	157.325	161.925
04	156.200	160.800	14	156.700	156.700	24	157.200	161.800	65	156.275	160.875	77	156.875	156.875	87	157.375	161.975
05	156.250	160.850	15*1	156.750	156.750	25	157.250	161.850	66	156.325	160.925	78	156.925	161.525	88	157.425	162.025
06	156.300	156.300	16	156.800	156.800	26	157.300	161.900	67	156.375	156.375	79	156.975	161.575			
07	156.350	160.950	17	156.850	156.850	27	157.350	161.950	68	156.425	156.425	80	157.025	161.625			
08	156.400	156.400	18	156.900	161.500	28	157.400	162.000	69	156.475	156.475	81	157.075	161.675			
09	156.450	156.450	19	156.950	161.550	60	156.025	160.625	70*2	156.525	156.525	82	157.125	161.725			
10	156.500	156.500	20	157.000	161.600	61	156.075	160.675	71	156.575	156.575	83	157.175	161.775			

•U.S.A. channels (for U.K. and Italy versions only)

CH	Frequency (MHz)		CH	Frequency (MHz)		CH	Frequency (MHz)		CH	Frequency (MHz)		CH	Frequency (MHz)		CH	Frequency (MHz)	
	Transmit	Receive		Transmit	Receive		Transmit	Receive		Transmit	Receive		Transmit	Receive		Transmit	Receive
01A	156.050	156.050	12	156.600	156.600	22A	157.100	157.100	64A	156.225	156.225	77*1	156.875	156.875	86	157.325	161.925
02A	156.100	156.100	13*3	156.650	156.650	23A	157.150	157.150	65A	156.275	156.275	78A	156.925	156.925	86A	157.325	157.325
03A	156.150	156.150	14	156.700	156.700	24	157.200	161.800	66A	156.325	156.325	79A	156.975	156.975	87	157.375	161.975
04A	156.200	156.200	15*3	156.750	156.750	25	157.250	161.850	67*3	156.375	156.375	80A	157.025	157.025	87A	157.375	157.375
05A	156.250	156.250	16	156.800	156.800	26	157.300	161.900	68	156.425	156.425	81A	157.075	157.075	88	157.425	162.025
06	156.300	156.300	17*1	156.850	156.850	27	157.350	161.950	69	156.475	156.475	82A	157.125	157.125	88A	157.425	157.425
07A	156.350	156.350	18A	156.900	156.900	28	157.400	162.000	70*2	156.525	156.525	83A	157.175	157.175			
08	156.400	156.400	19A	156.950	156.950	60A	156.025	156.025	71	156.575	156.575	84	157.225	161.825			
09	156.450	156.450	20	157.000	161.600	61A	156.075	156.075	72	156.625	156.625	84A	157.225	157.225			
10	156.500	156.500	20A	157.000	157.000	62A	156.125	156.125	73	156.675	156.675	85	157.275	161.875			
11	156.550	156.550	21A	157.050	157.050	63A	156.175	156.175	74	156.725	156.725	85A	157.275	157.275			

*1 Low power only *2 Receive only (except DSC transmission) *3 Momentarily high power

General

- Frequency coverage : Transmit 156–157.5 MHz
Receive 156–163 MHz
- Usable channels : All International channels
All U.S.A. channels additionally for
U.K./Italy versions.
- Mode : 16K0G3E, (16K0G2B when
optional DSC is in use)
- Power supply requirement : 13.8 V DC \pm 15%
- Current drain : Transmit
(at 13.8 V DC) high power 6.0 A
low power 1.5 A
Receive
standby 350 mA
max. audio output 1.2 A
- Frequency stability : \pm 1.5 kHz
- Usable temp. range : -20°C to $+60^{\circ}\text{C}$
- Dimensions : 140(W)x55(H)x155(D) mm
(projections not included)
- Weight : 1.0 kg

Transmitter

- Output power : High 25 W Low 1 W
- Modulation system : Variable reactance phase
modulation
- Max. frequency deviation : \pm 5.0 kHz
- Spurious emissions : Less than -70 dB
- Microphone impedance : 600 Ω

Receiver

(Measurement method: ETS300-162)

- Receive system : Double conversion
superheterodyne
- Intermediate frequencies : 1st 21.8 MHz 2nd 455 kHz
- Sensitivity : 0.32 μV for 20dB SINAD
- Squelch sensitivity : 0.32 μV at threshold
- Adjacent channel : More than 70 dB
selectivity
- Spurious response : More than 70 dB
rejection
- Intermodulation rejection : More than 68 dB
- Audio output power : 2 W at 10% distortion
- Audio output impedance : 4 Ω

All stated specifications are subject to change without notice or obligation.

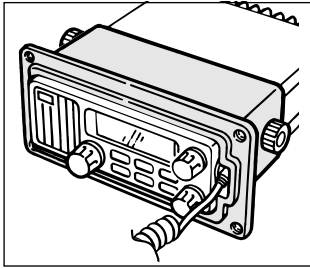

MB-28 FLUSH MOUNT

For mounting the IC-M59EURO to a panel. Available in black or white.

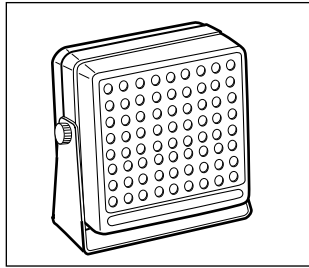

SP-5 EXTERNAL SPEAKER

A large, external speaker for superior audio output.

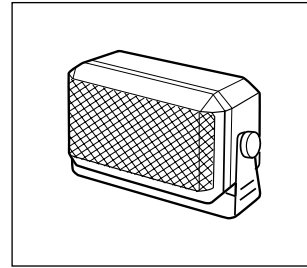

SP-10 EXTERNAL SPEAKER

A compact, external speaker. Features easy installation.

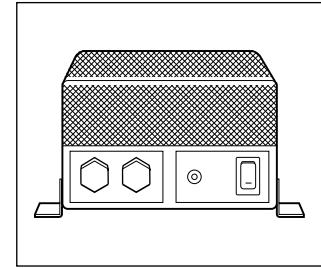

PS-66 DC-DC CONVERTER

Input voltage: 19 to 32 V DC
Output voltage: 13.6 V DC

◆ INTERNAL UNITS

•UT-79 VOICE SCRAMBLER UNIT

Provides private communications. Analog-type voice scrambling unit with 128 scramble codes available. Usable only where permitted by law.

•UX-120 DSC UNIT (with RC-18 DISTRESS SWITCH BOX)

When the UX-120 is installed, the transceiver conforms to DSC class-F for marine digital communications.

•OPC-457 NMEA CABLE

Allows you to connect NMEA equipment such as a GPS receiver.

Count on us!

A-5498D-1EU
Printed in Japan
© 1998 Icom Inc.

Icom Inc.
6-9-16 Kamihigashi, Hirano-ku, Osaka 547-0002 Japan